



DESIGN HIGHLIGHTS

- Quiet smooth lifting action at approximately 40mm [1.6] per second
- 180° of quiet, fast screen rotation in both directions with programmable viewing positions
- Full cable management
- Wide range of mounting options
- 24V DC motor. Suitable for direct DC supply
- Marine suitable robust beam

OPTIONS

- Fixed Screen Lid
- Custom screen back cover
- Heavy duty option

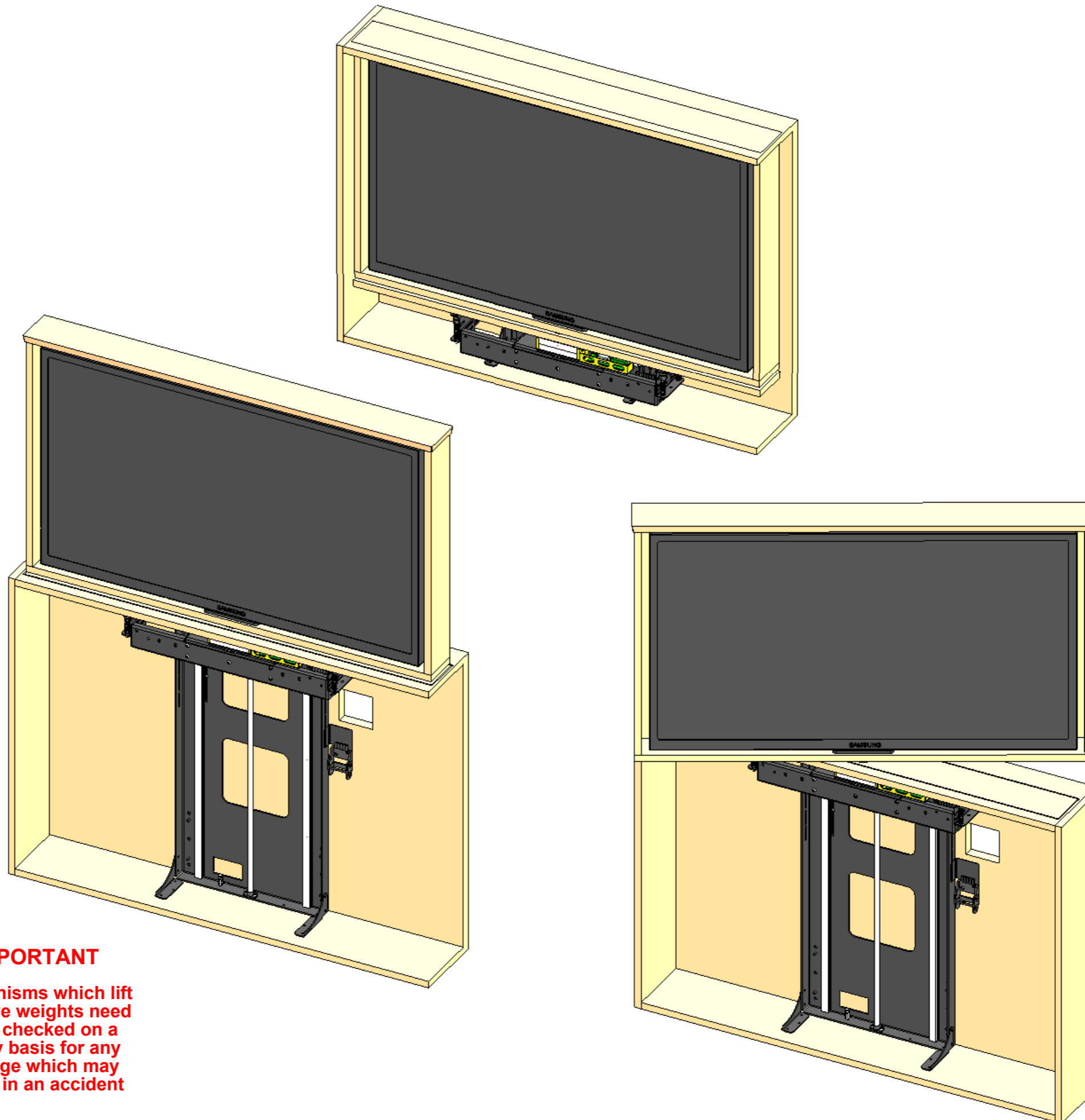

FUNCTION

An electric mechanism to lift a flat screen television. Suitable for marine use. Shown here for use with an enclosed screen and an electric 2 way swivel.

SUITABILITY

Suitable for a total lifting weight of 50Kg [110lbs] or 30Kg [66lbs] in a marine environment. This is the weight of the screen and box enclosure that is made by others. This enclosure can easily take 10Kg [22lbs] of the total capacity.

Maximum Screen Height 745mm [29.3]

Lift systems to suit different screen heights are available.

SPECIFYING

Check screen mounting details and request a suitable mount plate. Check for screen connectors that may add to screen depth.

CONTROL

Supplied with basic infrared remote. Can be learnt by many learning remotes.

Also has switch control and RS232 so can be operated by relays, switches, Crestron / AMX or Lutron systems.

WARNING

It is the responsibility of the installer to warn all potential end users of the dangers of interfering with mechanisms during operation

IMPORTANT

Mechanisms which lift or move weights need to be checked on a yearly basis for any damage which may result in an accident

Design Highlights

A space efficient and robust lifting mechanism, suitable for use in marine environments.

A robust, quiet and fast moving Electric Swivel Unit allows for 180° of screen rotation in both directions. Favourite viewing positions can be stored.

The Box Enclosure gives the product a neat finish, concealing all screen connections so that they can not be seen as the screen is rotated.

A robust 24V DC motor with a purpose made lead screw enables a quiet and smooth lifting action at approximately 40mm [1.6] per second.

High precision linear guideways ensure stability and durability of the beam to prevent any unwanted movement of the screen.

Adjustable UP and DOWN positions allow for a precise final setup within the cabinet.

The safety switched base reduces the risk of damage to the mechanism or injury to the user by cutting power to the motor when there is an obstruction between the cabinet and base panel.

Full cable management protects all screen and power cables from damage and is easily accessible for future changes to the AV setup.

A wide range of mounting options are available to suit different screens and speaker arrangements.

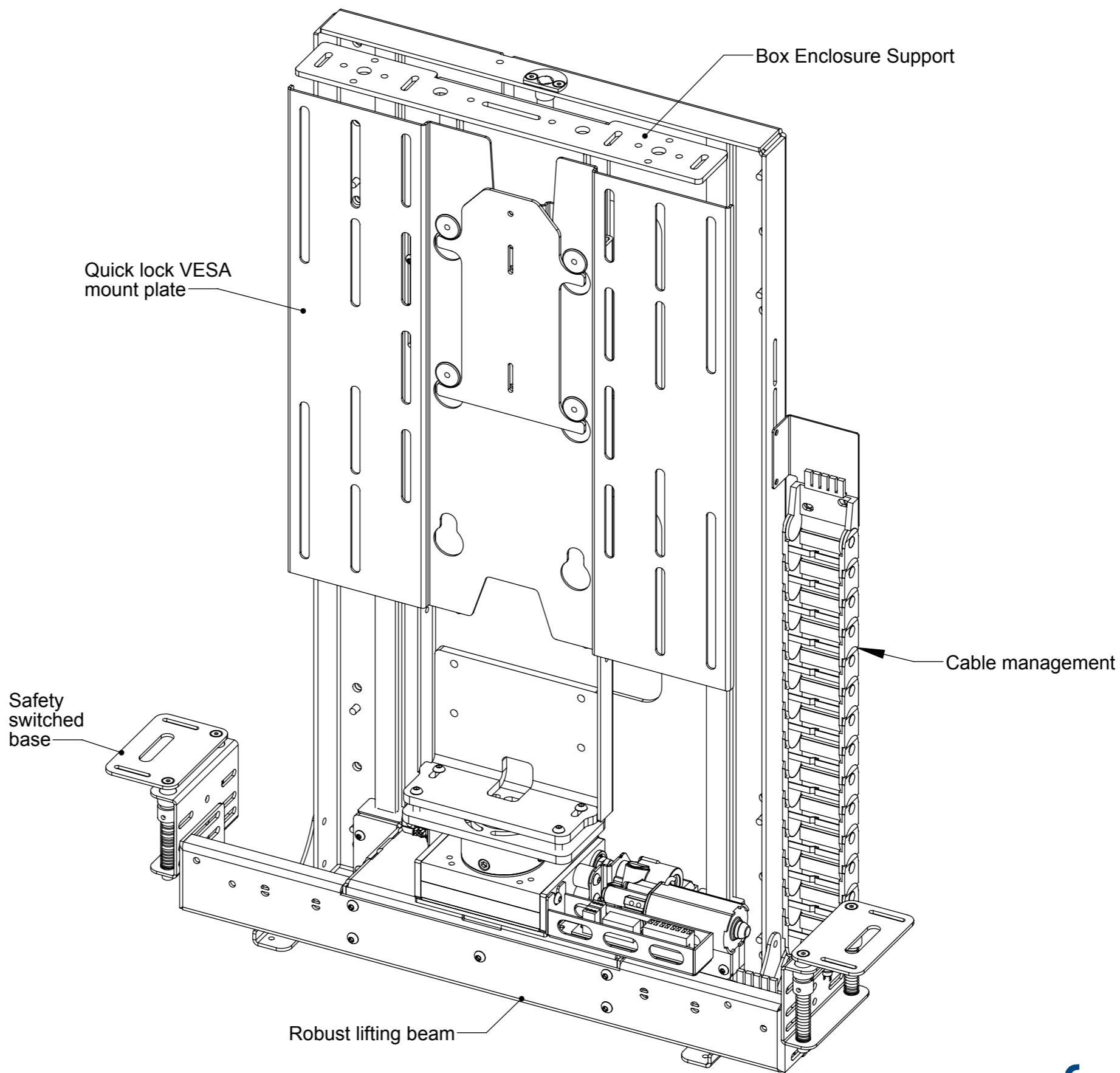

Cable Routing

Cables from the screen can be routed down through the Screen Mount and Swivel Unit and into the LSM Beam. Cables must be routed carefully to prevent any interference with the LSM beam as it operates.

Screen and Mechanism cables should be routed to a control box outside of the cabinet via an opening in the back of the cabinet or a conduit leading to the bottom.

- SCREEN CABLE
- MECHANISM CABLE
- POWER CABLE

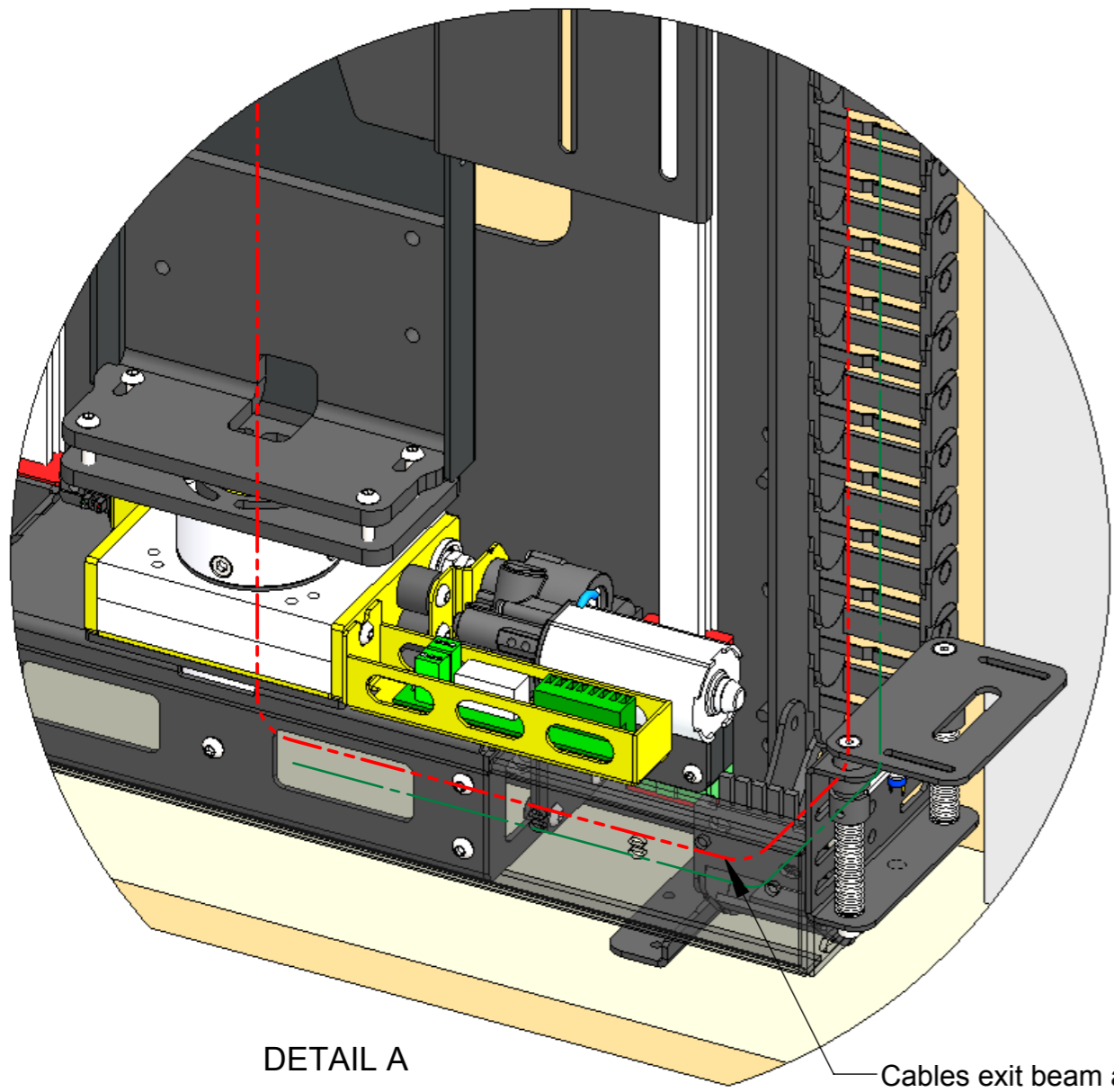

Cables exit beam and enter cable track

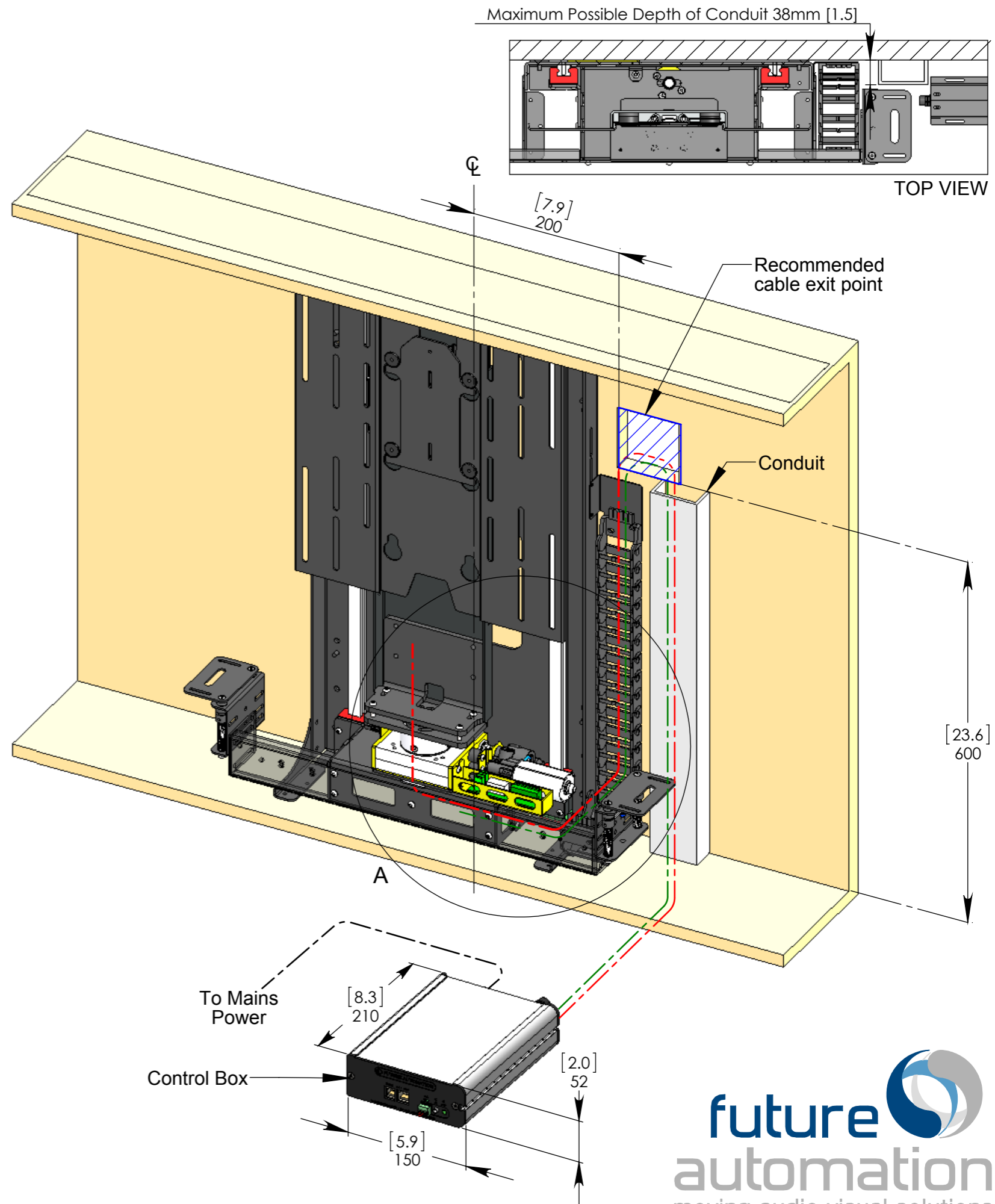

Mechanism Up - In Cabinet

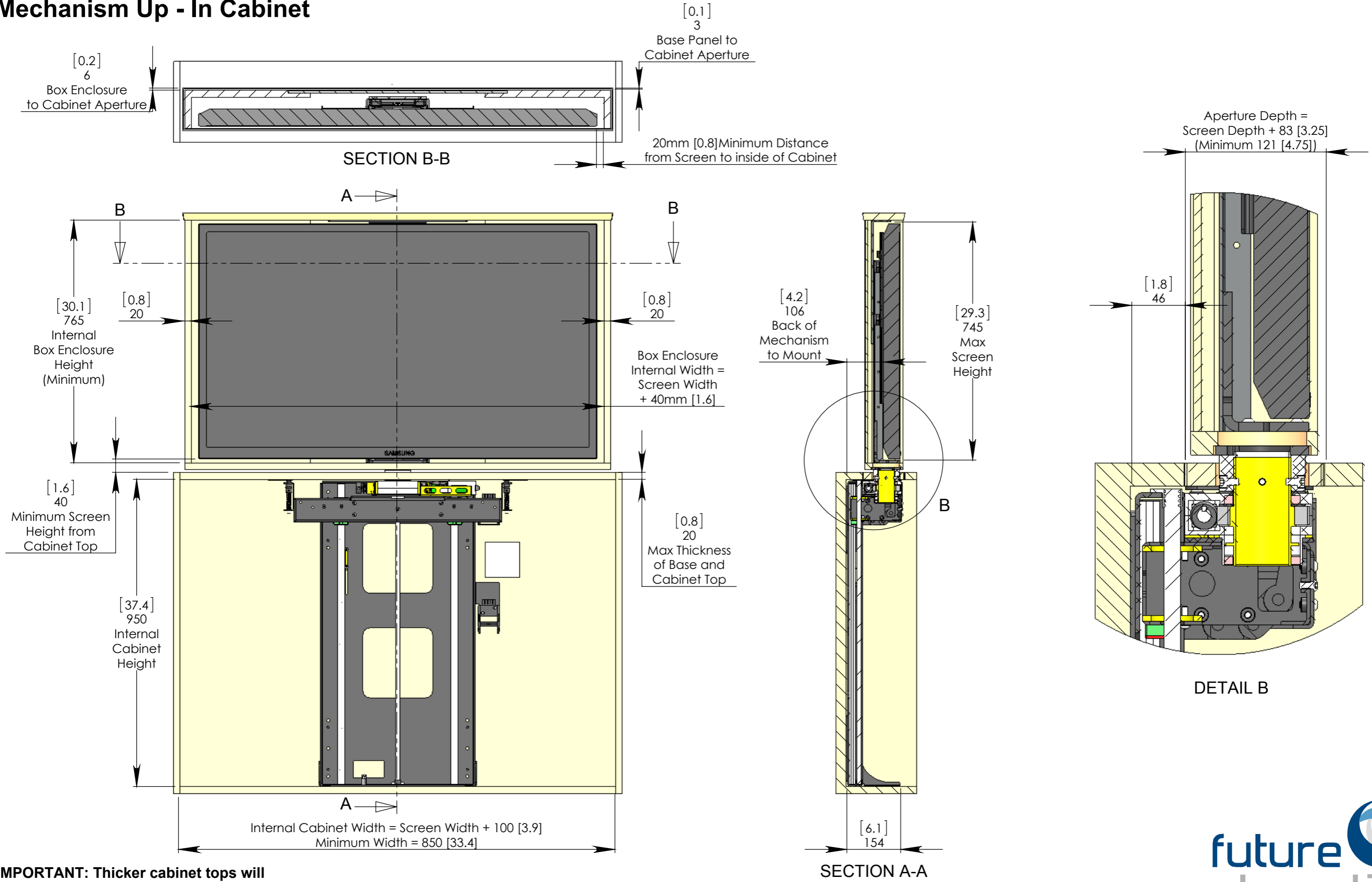

IMPORTANT: Thicker cabinet tops will require a reduced maximum screen height

Mechanism Down - In Cabinet

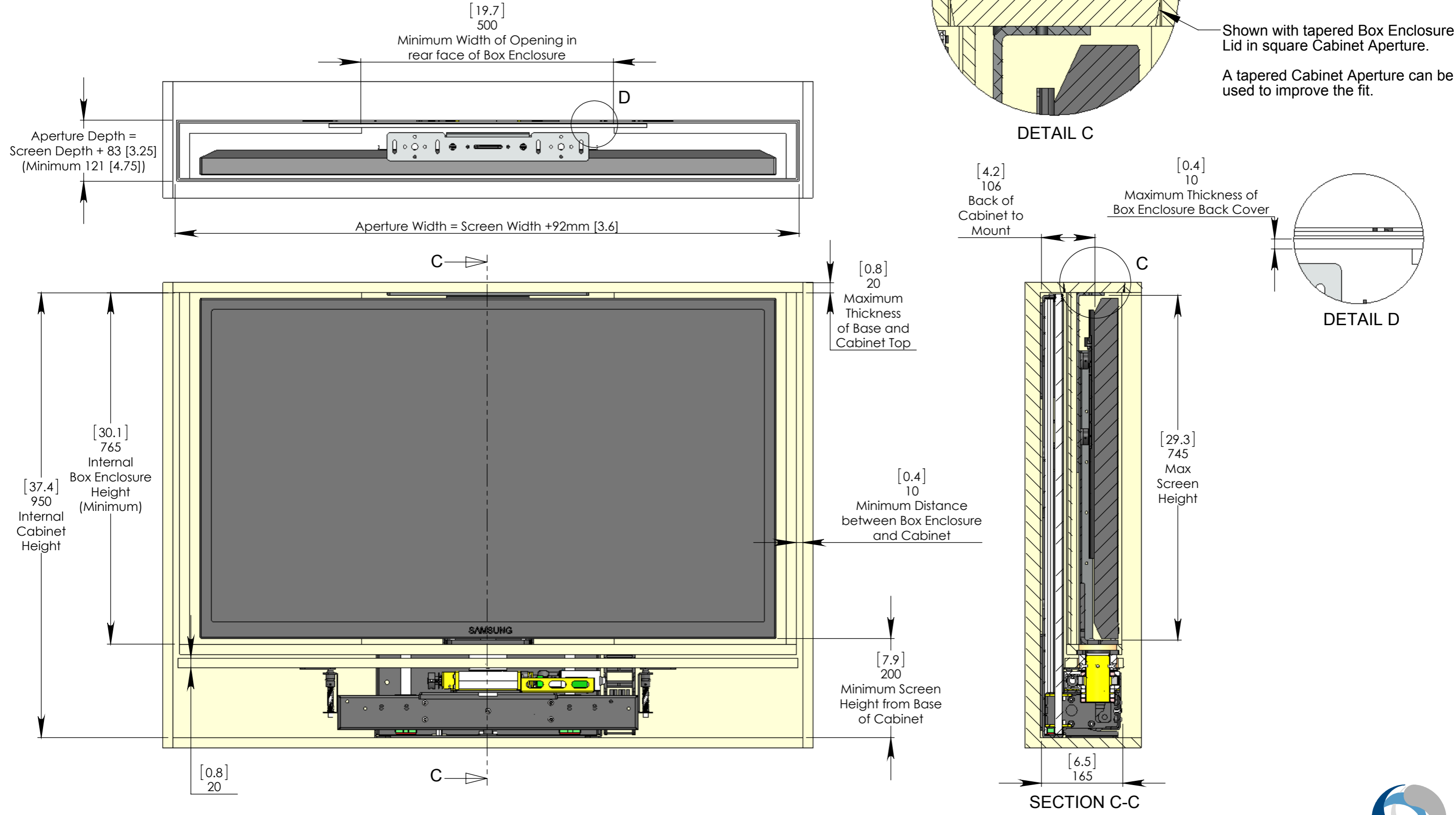

IMPORTANT: Thicker cabinet tops will require a reduced maximum screen height

Base Panel and Box Enclosure Lid Details

NOTE: A tapered Box Enclosure Lid creates a good fit in the Cabinet Aperture and helps the Box Enclosure to locate within the cabinet.

BOX ENCLOSURE LID (TAPERED) - TOP VIEW

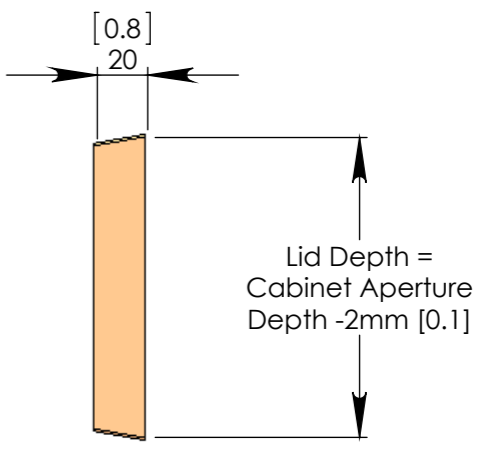
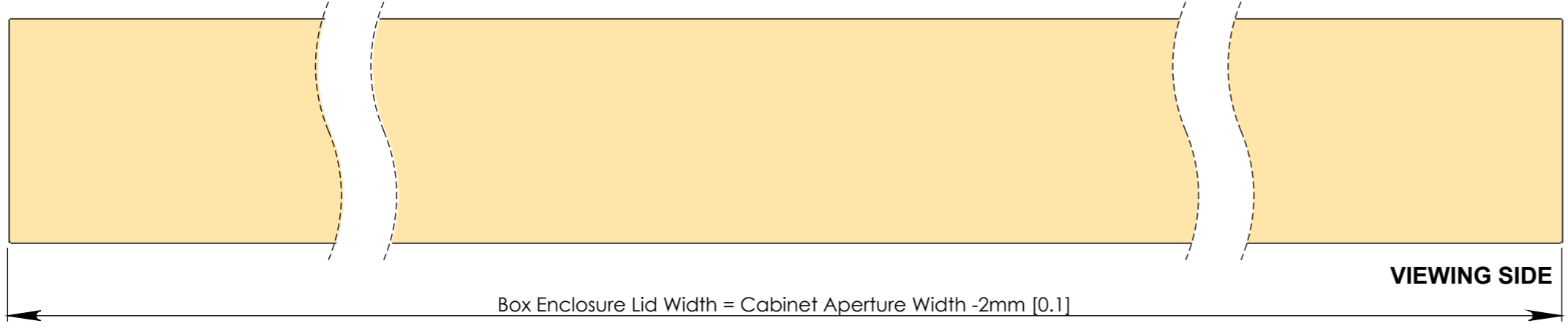

BASE PANEL - TOP VIEW

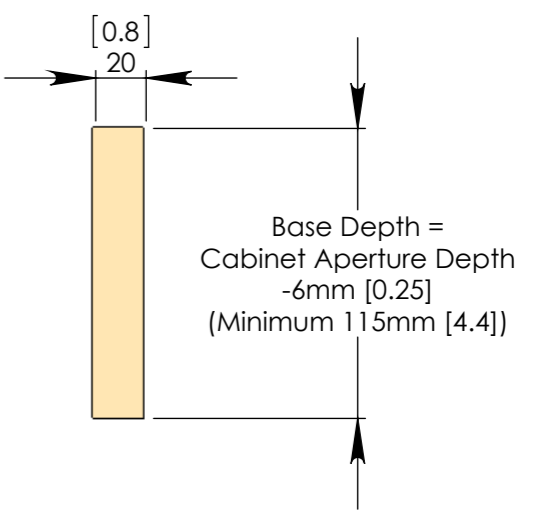
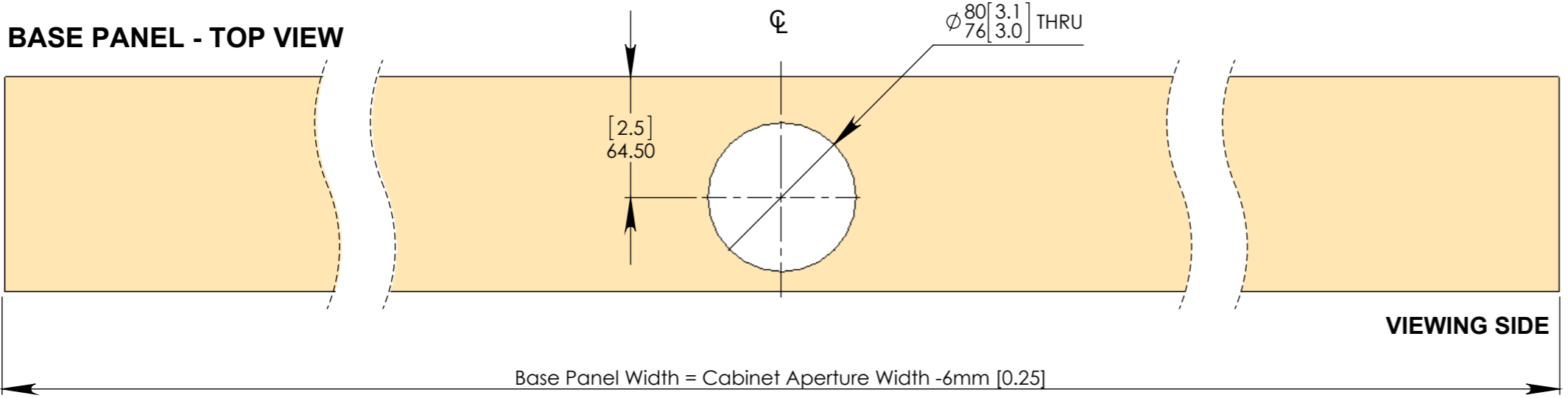

Box Enclosure Base Details

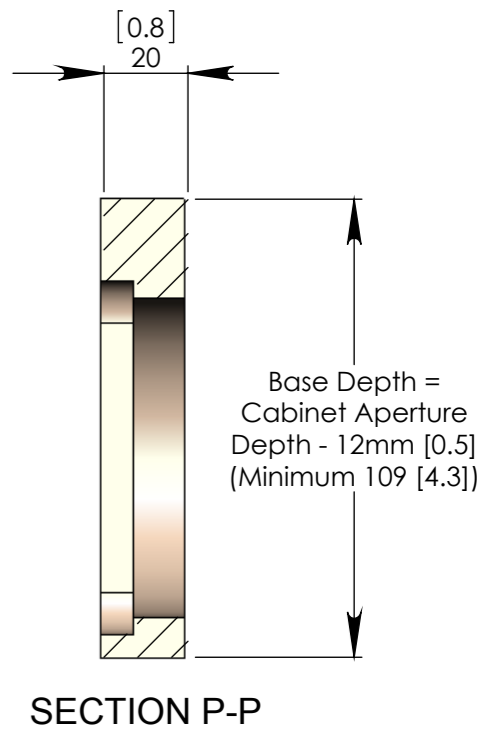
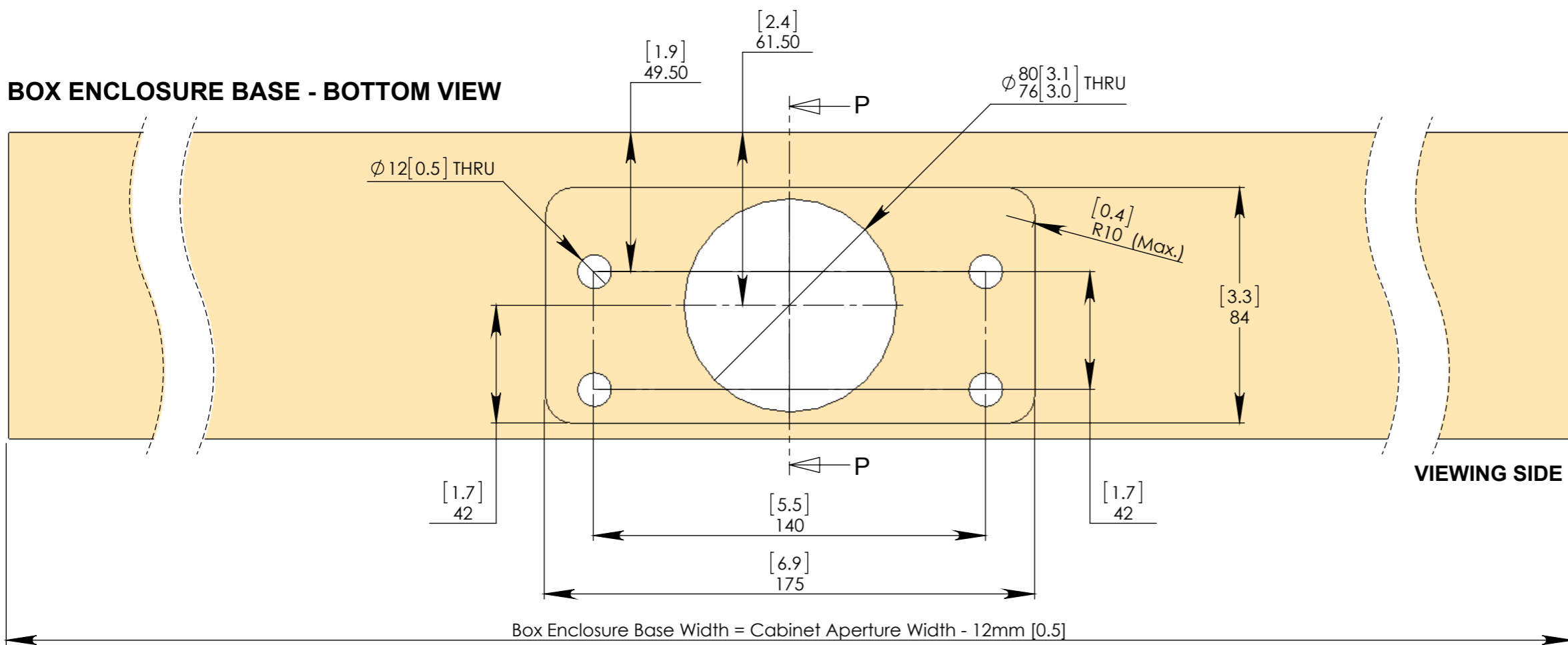

Screen Mount Adjustability

A standard adjustable height VESA 400 mount is included. This is also compatible with VESA 300 and 200 mounting patterns

Separate VESA 300 and 200 mounts are available.

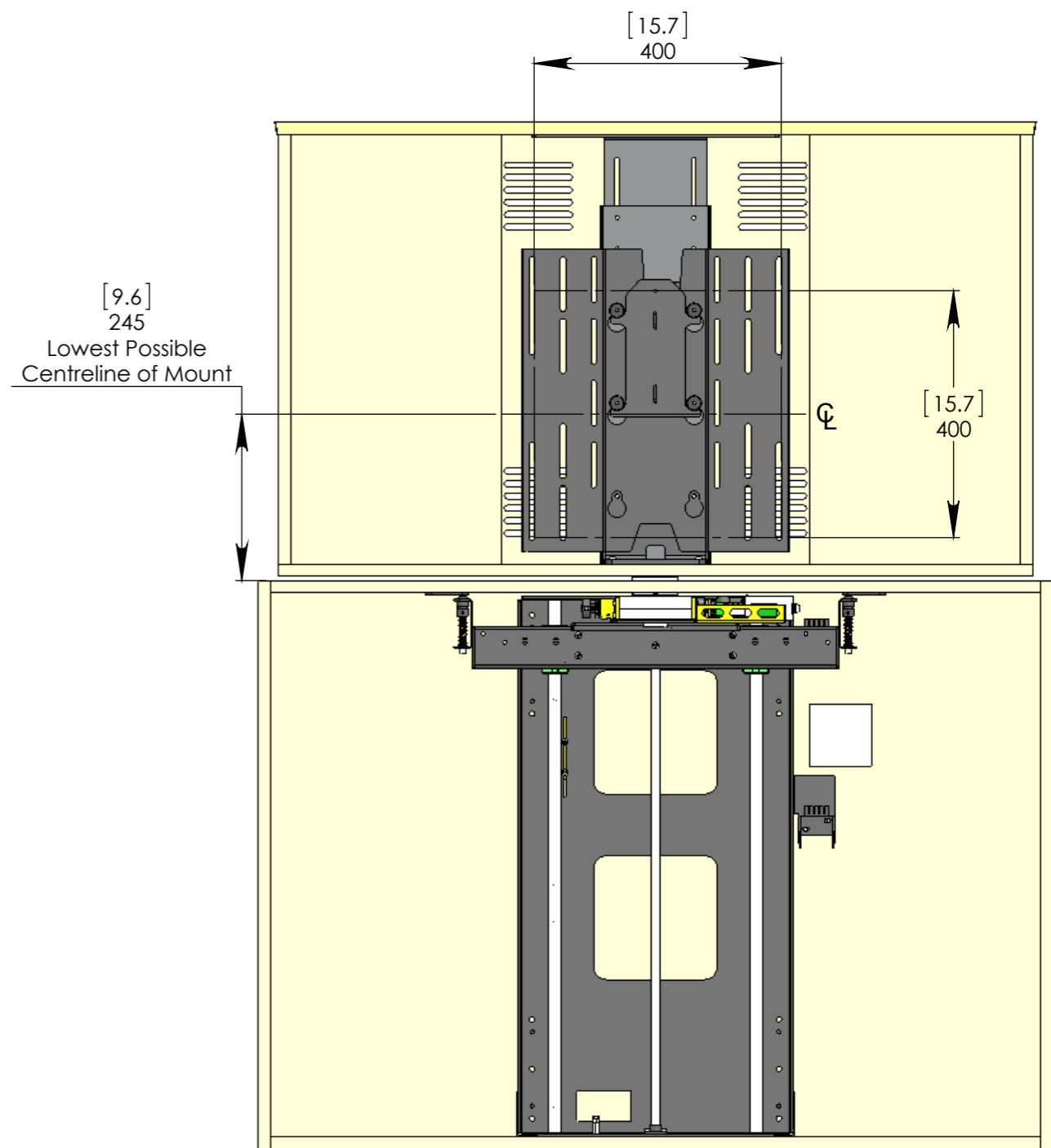
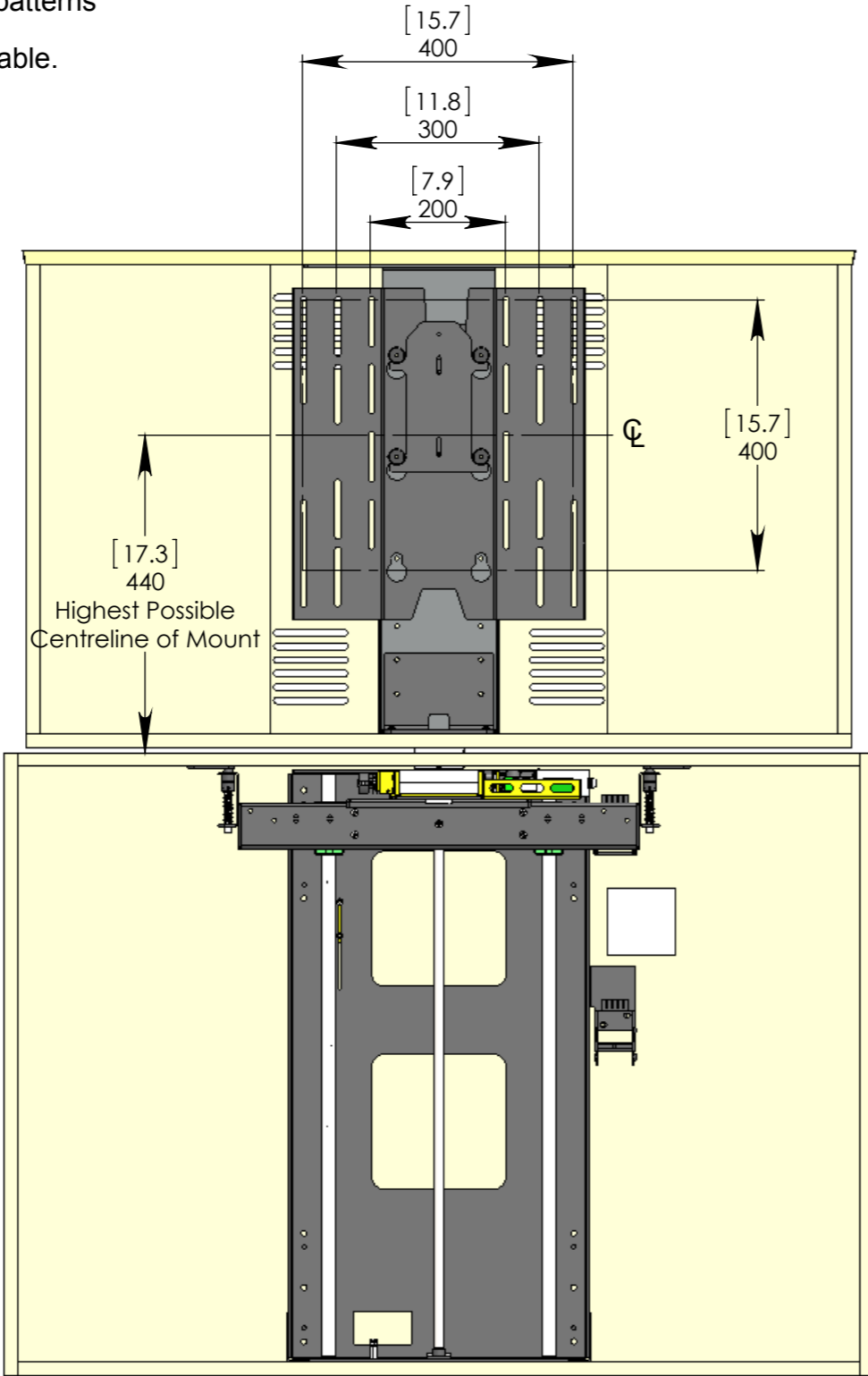
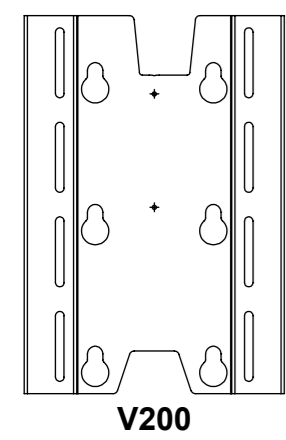
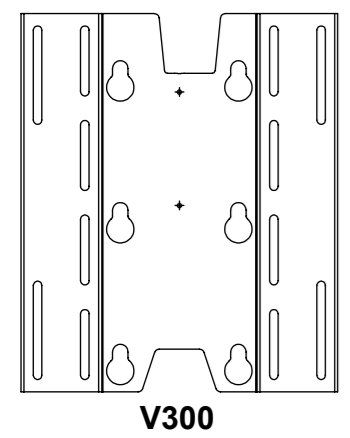
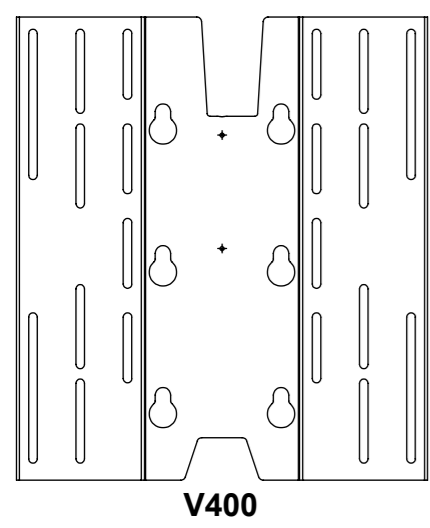

Mechanism Installation Overview

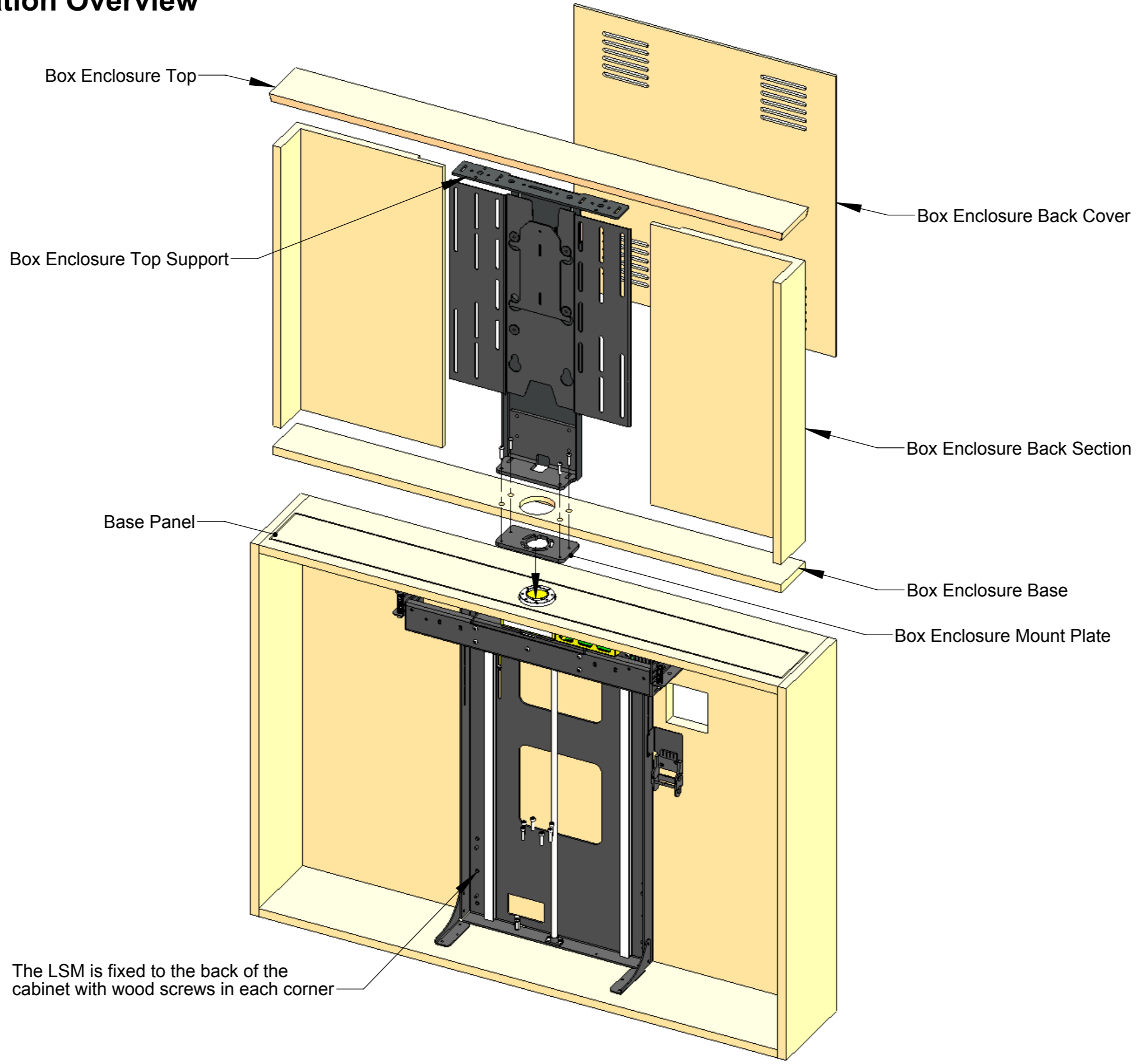

Overall Mechanism Dimensions

MECHANISM - UP POSITION

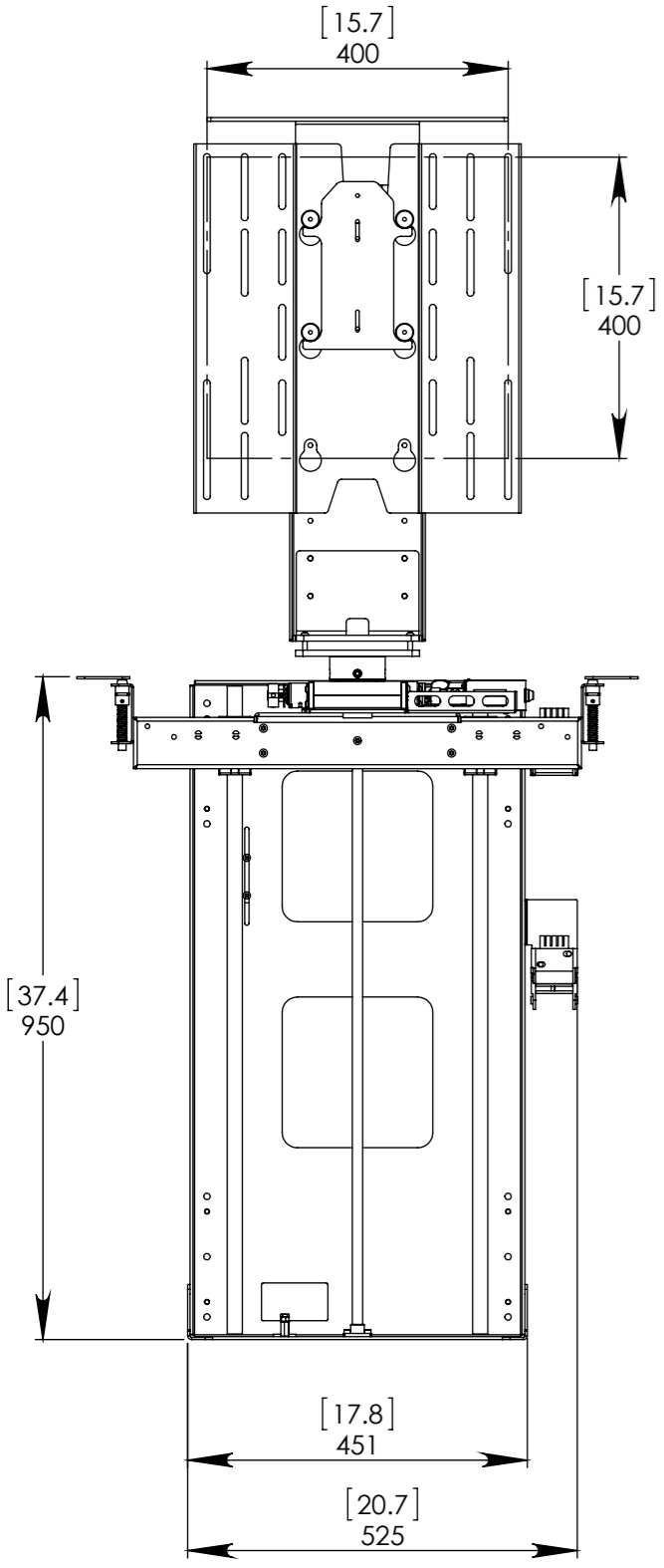

MECHANISM - DOWN POSITION

